

## 1-Line, Bi-directional, Transient Voltage Suppressor

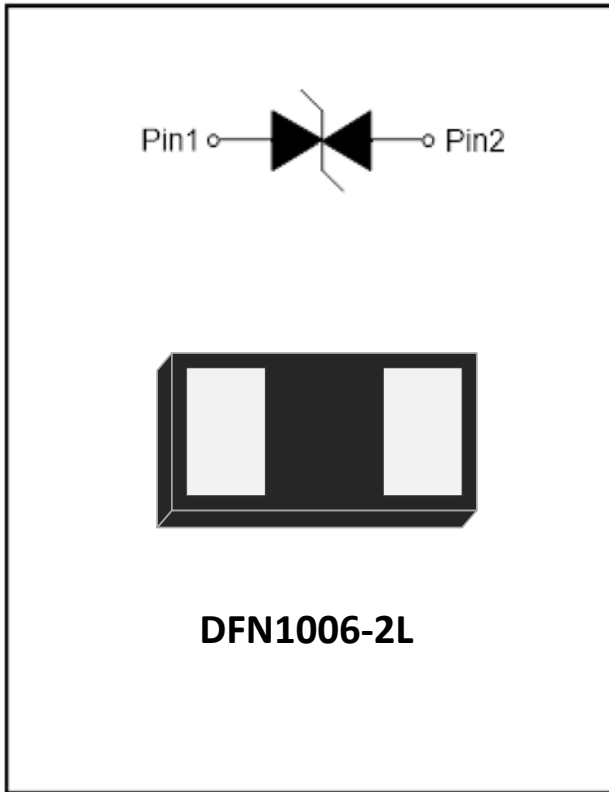

### Features

- Stand-off voltage:  $\pm 3.3V$  Max
- Transient protection for each line according to
  - IEC61000-4-2(ESD):  $\pm 30kV$  (contact)
  - IEC61000-4-4 (EFT): 80A (5/50ns)
  - IEC61000-4-5(surge): 20A (8/20 $\mu s$ )
- Low leakage current
- Ultra-low capacitance:  $C_J = 35pF$  typ
- Low clamping voltage:  
 $V_{CL} = 5.6V$  typ. @  $I_{PP} = 16A$  (TLP)
- RoHS Compliant

### Applications

- Cellular Handsets
- Tablets
- Laptops
- Other portable devices
- Network communication devices

### Mechanical Data

- Package: DFN1006-2L
- Case Material: "Green" Molding Compound
- Moisture Sensitivity: Level 3 per J-STD-020
- Marking Information: See Below

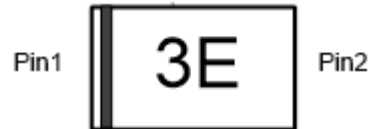

### Definitions of electrical characteristics

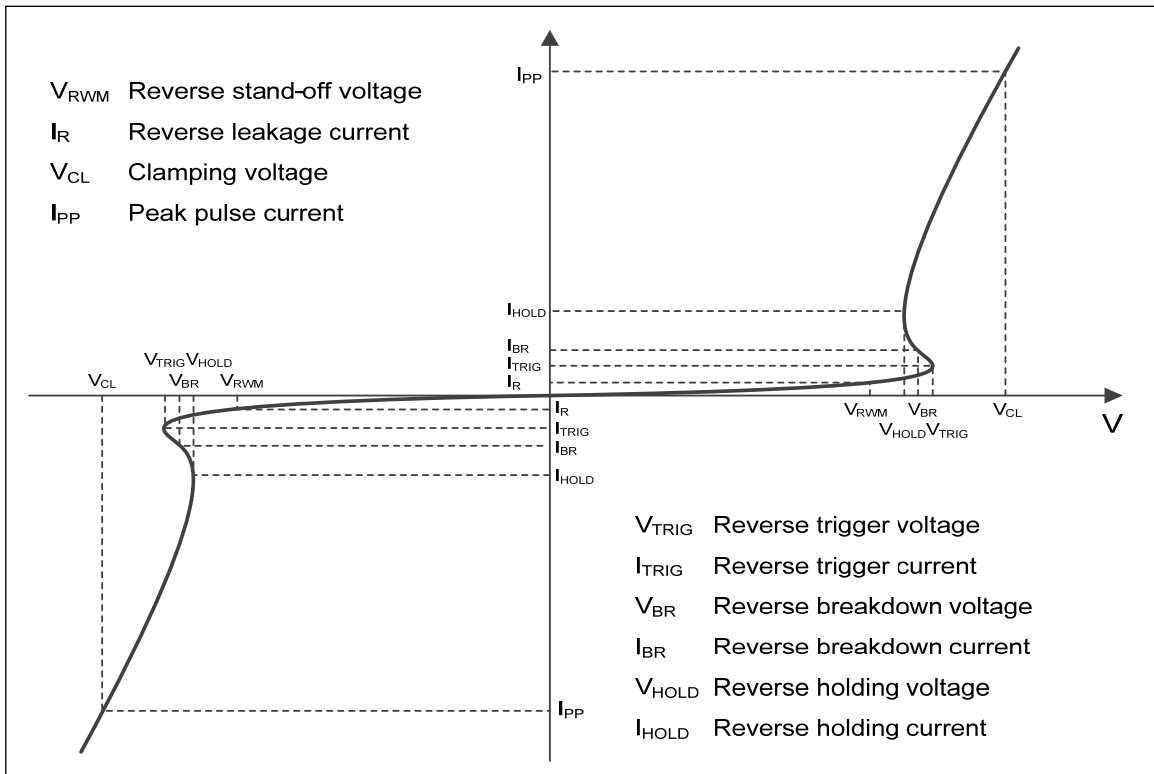



# ESD3V3LBA4

## ■Maximum Ratings

PARAMETER	SYMBOL	LIMITS	UNIT
Peak pulse power ( $t_p = 8/20\mu s$ )	$P_{pk}$	170	W
Peak pulse current ( $t_p = 8/20\mu s$ )	$I_{PP}$	20	A
ESD according to IEC61000-4-2 air discharge	$V_{ESD}$	$\pm 30$	kV
ESD according to IEC61000-4-2 contact discharge		$\pm 30$	
Junction temperature	$T_J$	-55~125	$^{\circ}C$
Storage temperature	$T_{STG}$	-55~150	$^{\circ}C$

## ■Electrical Characteristics ( $T_a=25^{\circ}C$ Unless otherwise specified)

PARAMETER	Symbol	UNIT	Conditions	Min	Typ	Max
Reverse maximum working voltage	$V_{RWM}$	V				$\pm 3.3$
Reverse leakage current	$I_R$	$\mu A$	$V_{RWM} = 3.3V$			0.1
Reverse breakdown voltage	$V_{BR}$	V	$I_{BR} = 1mA$	3.5	4	
Reverse holding voltage	$V_{HOLD}$	V	$I_{HOLD} = 50mA$	3.5	4	
Clamping voltage <sup>1)</sup>	$V_{CL}$	V	$I_{PP} = 16A, t_p = 0.2/100ns(TLP)$		5.6	
Dynamic resistance <sup>1)</sup>	$R_{DYN}$	$\Omega$			0.1	
Clamping voltage <sup>2)</sup>	$V_{CL}$	V	$V_{ESD} = 8kV$		8	
Clamping voltage <sup>1)</sup>	$V_{CL}$	V	$I_{PP} = 1A, t_p = 8/20\mu s$		4.3	5.5
		V	$I_{PP} = 10A, t_p = 8/20\mu s$		6	7.5
		V	$I_{PP} = 20A, t_p = 8/20\mu s$		7.5	9
Junction capacitance	$C_J$	pF	$V_R = 0V, f = 1MHz$		35	45
Junction capacitance	$C_J$	pF	$V_R = 2.5V, f = 1MHz$		25	35

Notes:

- 1) TLP parameter:  $Z_0 = 50\Omega, t_p = 100ns, t_r = 2ns$ , averaging window from 60ns to 80ns. RDYN is calculated from 4A to 16A.
- 2) Contact discharge mode, according to IEC61000-4-2.
- 3) Non-repetitive current pulse, according to IEC61000-4-5.

## ■Ordering Information (Example)

PREFERRED P/N	PACKING CODE	UNIT WEIGHT(mg)	MINIMUM PACKAGE(pcs)	INNER BOX QUANTITY(pcs)	OUTER CARTON QUANTITY(pcs)	DELIVERY MODE
ESD3V3LBA4	F1	Approximate 0.9	10000	100000	400000	7" reel



## ■ Characteristics (Typical)

Fig.1 8/20 $\mu$ s waveform per IEC61000-4-5

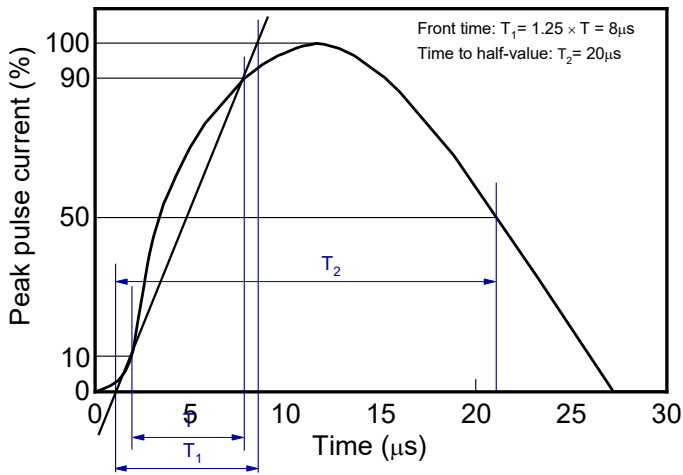

Fig.2 Contact discharge current waveform per IEC61000-4-2

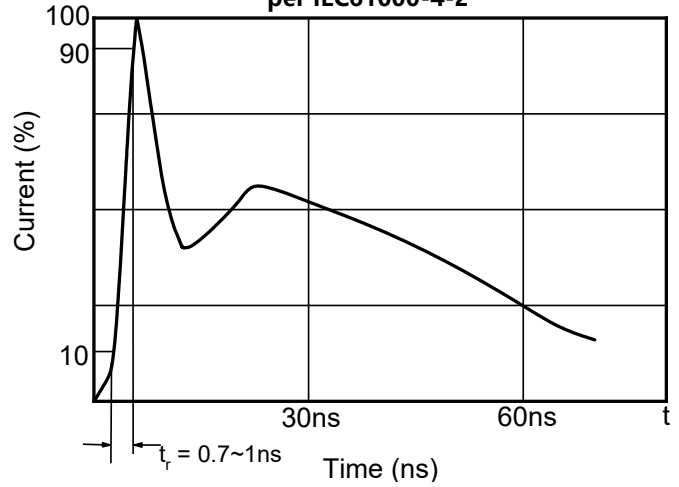

Fig.3 Clamping voltage vs. Peak pulse current

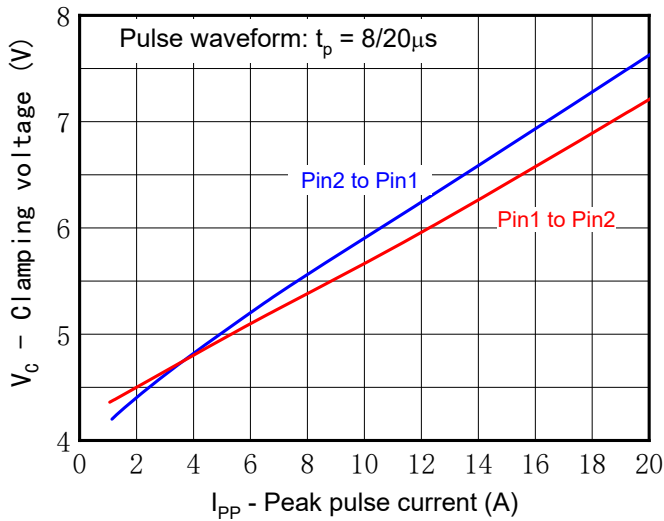

Fig.4 Capacitance vs. Reverse voltage

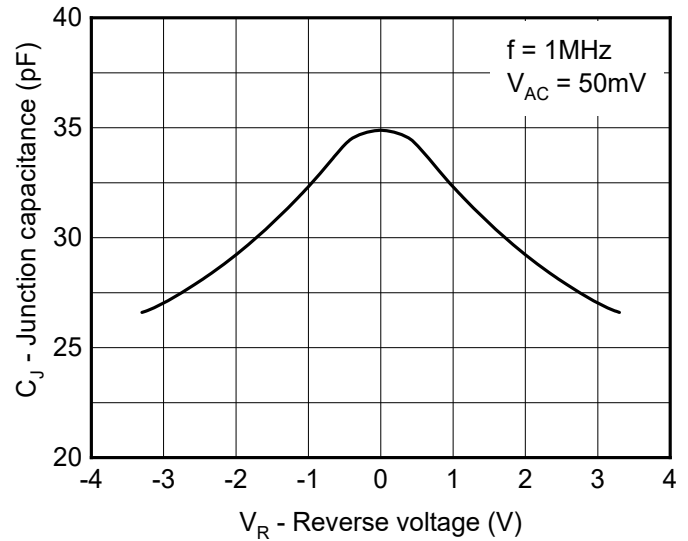

Fig.5 Non-repetitive peak pulse power vs. Pulse time

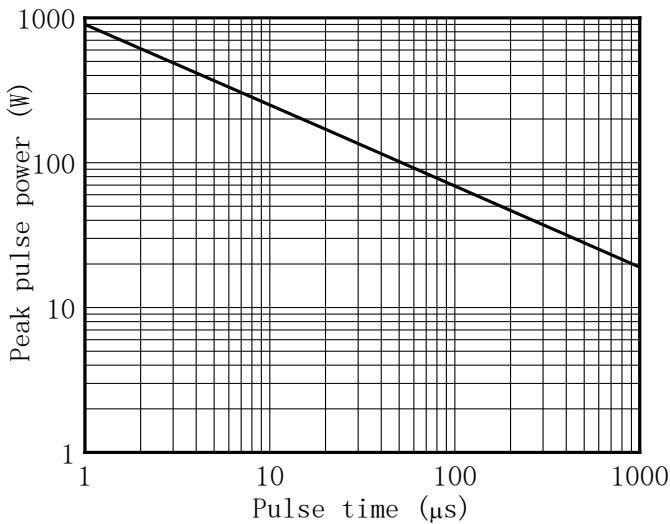
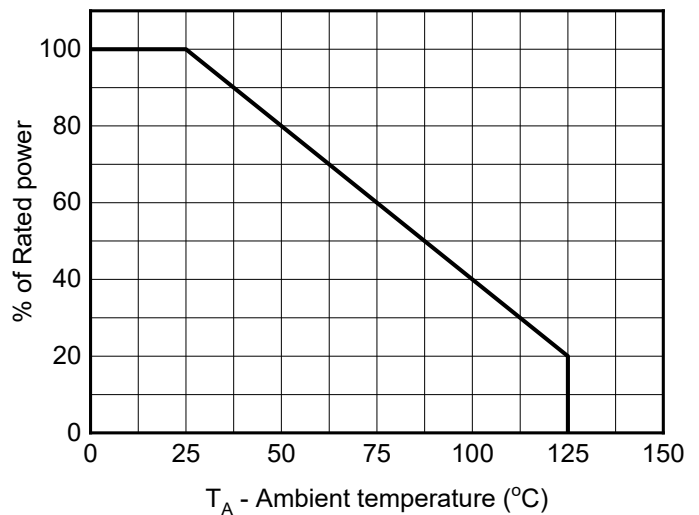

Fig.6 Power derating vs. Ambient temperature





# ESD3V3LBA4

Fig.7 ESD clamping

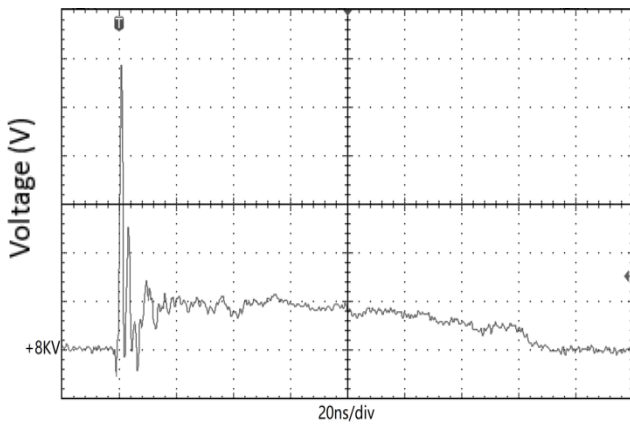

Time (ns)

(+8kV contact discharge per IEC61000-4-2)

Fig.8 ESD clamping t

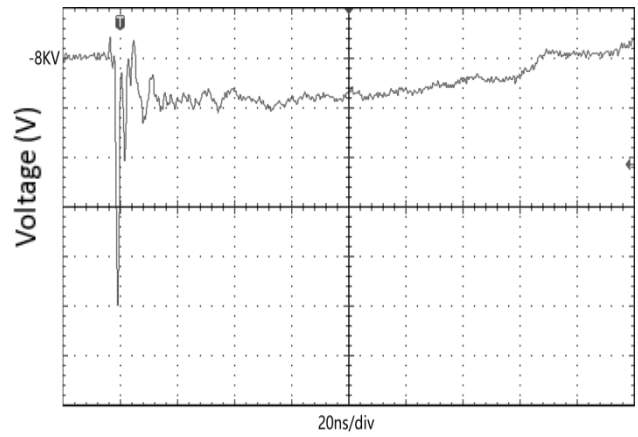

Time (ns)

(-8kV contact discharge per IEC61000-4-2)

Fig. 9 TLP Measurement

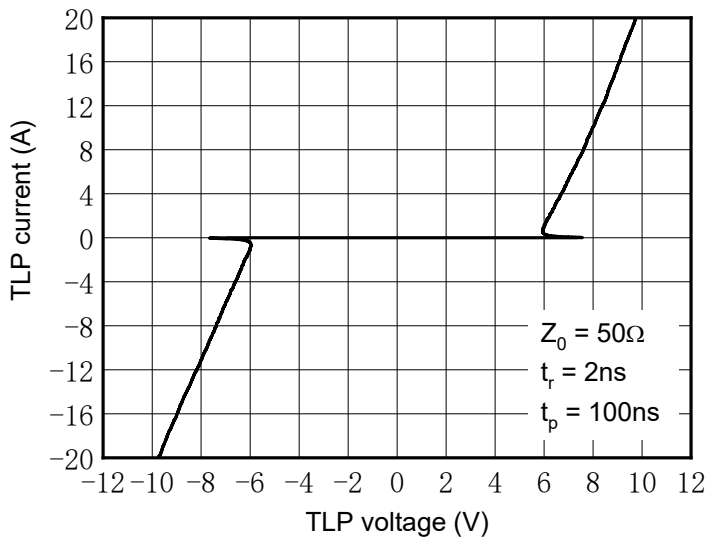

## ■ Outline Dimensions

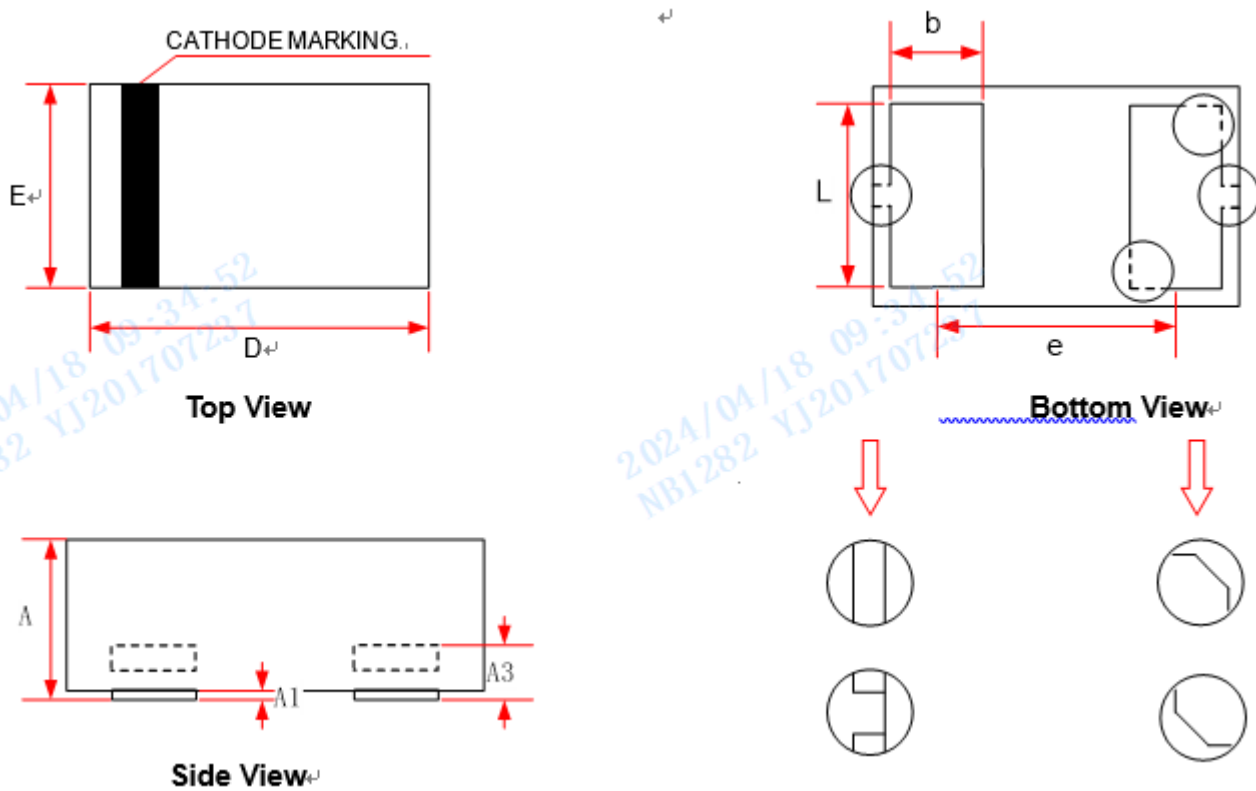

Symbol	Dimensions in Millimeters		
	Min.	Typ.	Max.
A	0.340	0.450	0.530
A1	0.000	0.020	0.050
A3	0.125 Ref.		
D	0.950	1.000	1.080
E	0.550	0.600	0.680
b	0.200	0.250	0.300
L	0.450	0.500	0.550
e	0.650 BSC		

## ■ Recommended PCB Layout

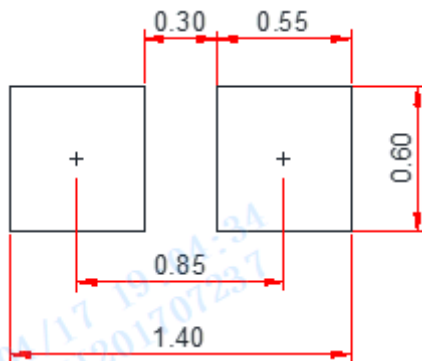

Unit:mm

### Notes:

This recommended land pattern is for reference purposes only. Please consult your manufacturing group to ensure your PCB design guidelines are met



## Disclaimer

The information presented in this document is for reference only. Yangzhou Yangjie Electronic Technology Co., Ltd. reserves the right to make changes without notice for the specification of the products displayed herein to improve reliability, function or design or otherwise.

The product listed herein is designed to be used with ordinary electronic equipment or devices, and not designed to be used with equipment or devices which require high level of reliability and the malfunction of which would directly endanger human life (such as medical instruments, transportation equipment, aerospace machinery, nuclear-reactor controllers, fuel controllers and other safety devices), Yangjie or anyone on its behalf, assumes no responsibility or liability for any damages resulting from such improper use of sale.

This publication supersedes & replaces all information previously supplied. For additional information, please visit our website [http:// www.21yangjie.com](http://www.21yangjie.com) , or consult your nearest Yangjie's sales office for further assistance.