

## ESD Protection Diode

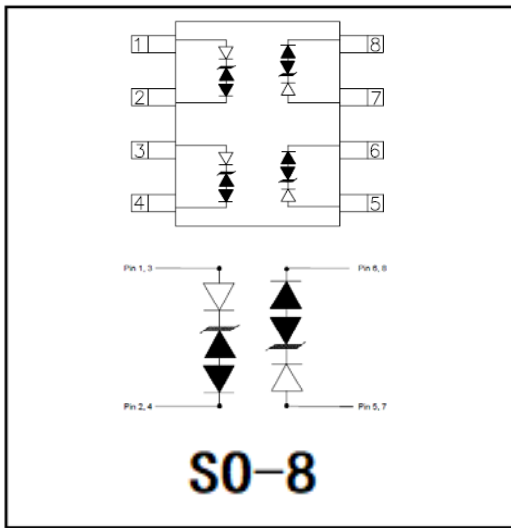

### Features

- Protects two line pairs (four lines)
- Ultra low clamping voltage
- Low operating voltage: 2.8V
- Moisture Sensitivity: Level 3 per J-STD-020
- JEDEC SO-8 package
- Marking:

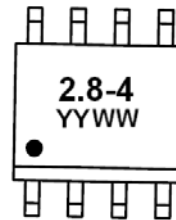

2.8-4= Device Marking Code  
YYWW = Date Code  
Dot denotes Pin1

### ■ Absolute Maximum Ratings (Ta=25°C unless otherwise specified)

PARAMETER	SYMBOL	VALUE	UNIT
Operating Temperature Range	T <sub>J</sub>	-55 to +125	°C
Storage Temperature Range	T <sub>STG</sub>	-55 to +150	°C
IEC61000-4-2(ESD)Air	V <sub>ESD</sub>	±30	KV
IEC61000-4-2(ESD)Contact		±30	KV
Peak Pulse Power(8/20μs)	P <sub>PP</sub>	600	W
Peak Pulse Current(8/20μs)	I <sub>PP</sub>	30	A

### ■ Electrical Characteristics (Ta=25°C Unless otherwise specified)

PARAMETER	Symbol	UNIT	Conditions	Min	Typ	Max
Reverse Working Voltage	V <sub>RWM</sub>	V				2.8
Reverse Leakage Current	I <sub>R</sub>	uA	V <sub>RWM</sub> =2.8V		0.001	1
Breakdown Voltage	V <sub>(BR)</sub>	V	I <sub>T</sub> =2uA	3		
	V <sub>(SB)</sub>	V	I <sub>SB</sub> =50mA	3		
Clamping Voltage	V <sub>C</sub> <sup>(1)</sup>	V	I <sub>PP</sub> =5A			8.5
Clamping Voltage	V <sub>C</sub>	V	I <sub>PP</sub> =25A			18
Clamping Voltage	V <sub>C</sub>	V	I <sub>PP</sub> =30A			20
Junction Capacitance	C <sub>J</sub>	pF	V <sub>R</sub> =0V, f=1MHz		2	3



# SLVU2.8-4

## ■ Thermal Characteristics (T<sub>a</sub>=25°C Unless otherwise specified)

PARAMETER	SYMBOL	UNIT	SLVU2.8-4
Thermal Resistance(Typical)	R <sub>θJ-A</sub>	°C/W	184
	R <sub>θJ-C</sub>	°C/W	74

## ■ Characteristics (Typical)

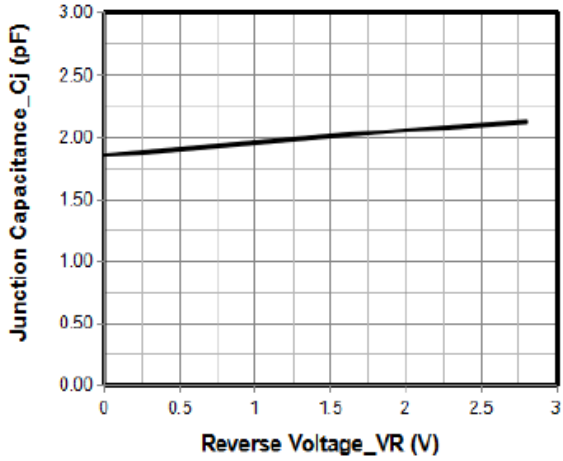

Junction Capacitance vs. Reverse Voltage

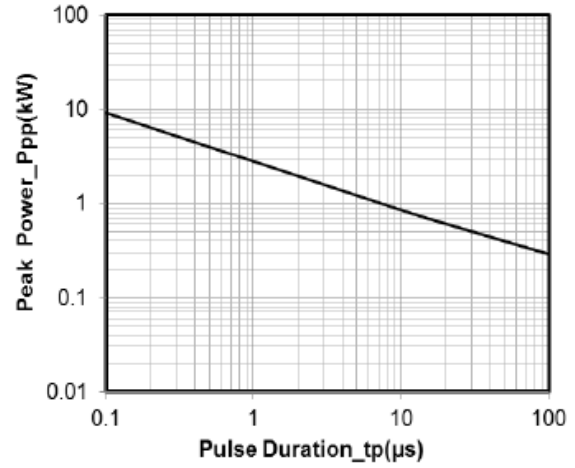

Peak Pulse Power vs. Pulse Time

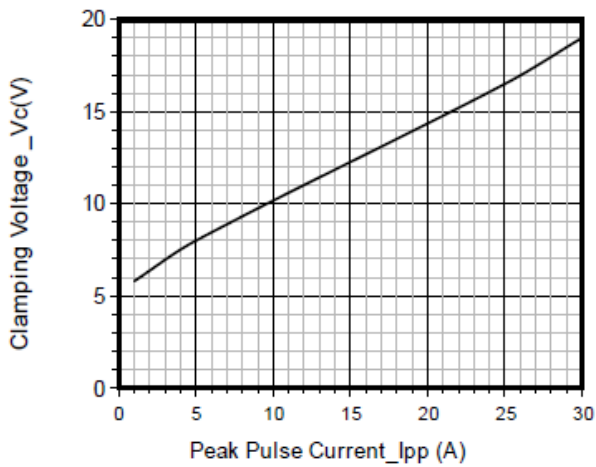

Clamping Voltage vs. Peak Pulse Current

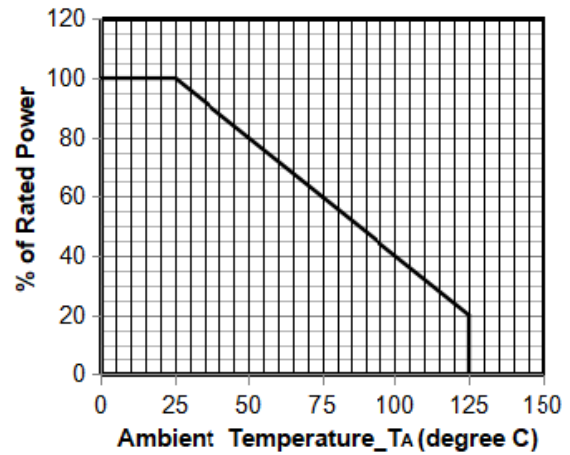

Power Derating Curve

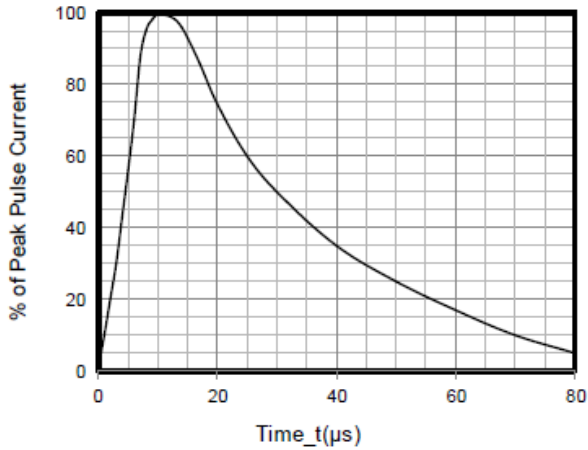

8 X 20µs Pulse Waveform

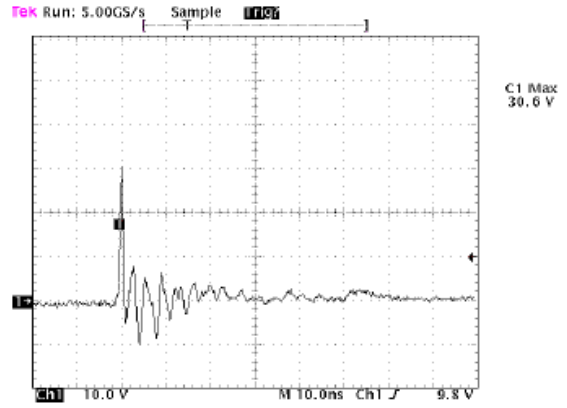

Note: Data is taken with a 10x attenuator

ESD Clamping Voltage  
8 kV Contact per IEC61000-4-2

## Outline Dimensions

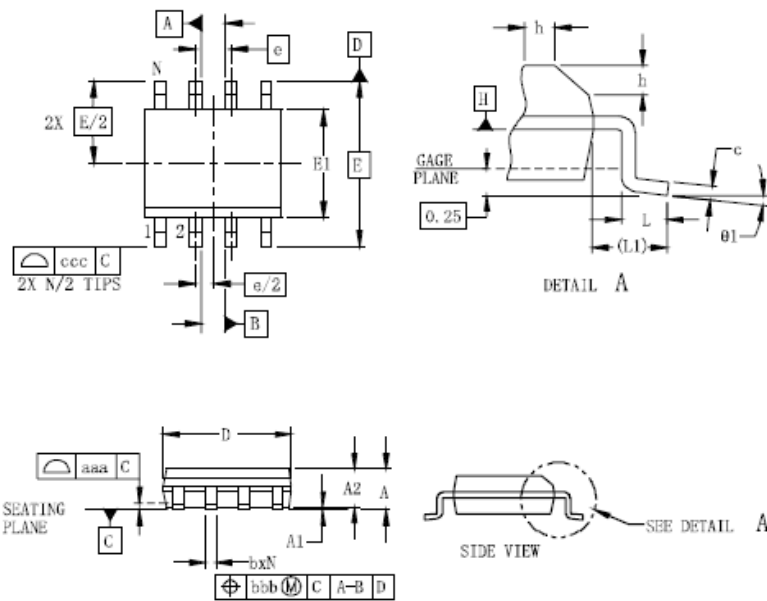

SYM	DIMENSIONS					
	MILLIMETERS			INCHES		
	MIN	NOM	MAX	MIN	NOM	MAX
A	1.35		1.75	0.053		0.069
A1	0.10		0.25	0.004		0.010
A2	1.25		1.65	0.049		0.065
b	0.31		0.51	0.012		0.020
c	0.17		0.25	0.007		0.010
D	4.80	4.90	5.00	0.189	0.193	0.197
E1	3.80	3.90	4.00	0.150	0.154	0.157
E	6.00 BSC			0.236 BSC		
e	1.27 BSC			0.050 BSC		
h	0.25		0.50	0.010		0.020
L	0.40	0.72	1.04	0.016	0.028	0.041
L1	(1.04)			(0.041)		
N	8			8		
theta1	0°		8°	0°		8°
aaa	0.10			0.004		
bbb	0.25			0.010		
ccc	0.20			0.008		

## Soldering Footprint

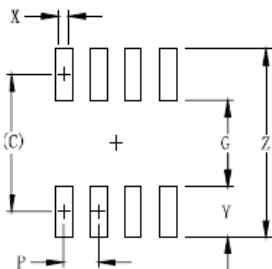

SYM	DIMENSIONS	
	MILLIMETERS	INCHES
C	(5.20)	0.205
G	3.00	0.118
P	1.27	0.050
X	0.60	0.024
Y	2.20	0.087
Z	7.40	0.291



### Disclaimer

The information presented in this document is for reference only. Yangzhou Yangjie Electronic Technology Co., Ltd. reserves the right to make changes without notice for the specification of the products displayed herein to improve reliability, function or design or otherwise.

The product listed herein is designed to be used with ordinary electronic equipment or devices, and not designed to be used with equipment or devices which require high level of reliability and the malfunction of which would directly endanger human life (such as medical instruments, transportation equipment, aerospace machinery, nuclear-reactor controllers, fuel controllers and other safety devices), Yangjie or anyone on its behalf, assumes no responsibility or liability for any damages resulting from such improper use of sale.

This publication supersedes & replaces all information previously supplied. For additional information, please visit our website [http:// www.21yangjie.com](http://www.21yangjie.com) , or consult your nearest Yangjie's sales office for further assistance.