

Schottky Rectifier

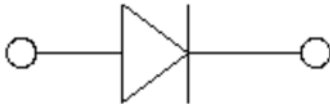

Features

- Moisture sensitivity level 1
- Reverse voltage: 40V
- Average forward current : 0.5A

Application

- High frequency and low voltage rectifier

Mechanical data

- **Package:** SOD-123
- **Terminals:** Tin plated leads, solderable per J-STD-002 and JESD22-B102

■ Maximum Ratings (T_a=25°C Unless otherwise specified)

Parameter	Symbol	Unit	Value
Device marking code			R41
Repetitive peak reverse voltage	V _{RRM}	V	40
Forward current	I _F	A	0.5
Non-repetitive surge peak forward current @ t=8.3ms half-sine wave	I _{FSM}	A	5.5
Non-repetitive surge peak forward current @ t=1ms square wave			10
Power dissipation	P _D	mW	410
Junction temperature	T _J	°C	-55 to +150
Storage temperature	T _{STG}	°C	-55 to +150



B0540W

RoHS
COMPLIANT

■ Electrical Characteristics (T_a=25°C Unless otherwise specified)

Parameter	Symbol	Unit	Conditions	Min	Typ	Max
Reverse voltage	V _R	V	I _R =20uA	40		
Forward voltage	V _{F1}	V	I _F =0.5A			0.51
	V _{F2}	V	I _F =1A			0.62
Reverse leakage current	I _{R1}	uA	V _R =20V			10
	I _{R2}	uA	V _R =40V			20
Junction capacitance	C _j	pF	V _R =4V, f =1MHZ		30	

■ Thermal Characteristics

Parameter	Symbol	Unit	Value
Thermal resistance, junction-to-ambient	R _{θJ-A} ⁽¹⁾	°C/W	305
Thermal resistance, junction-to-case	R _{θJ-C} ⁽¹⁾	°C/W	244

Note:

(1) Thermal resistance from junction to ambient and from junction to case mounted on P.C.B. with 8mm*9mm copper pad areas

■ Characteristics

Fig 1: P_D - T_a Curve

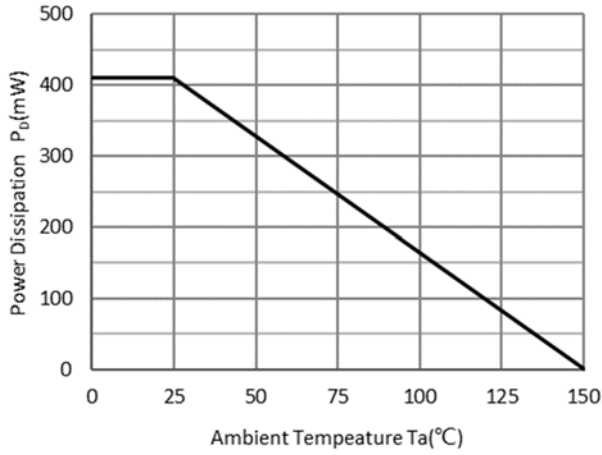

Fig 2: Capacitance Capability

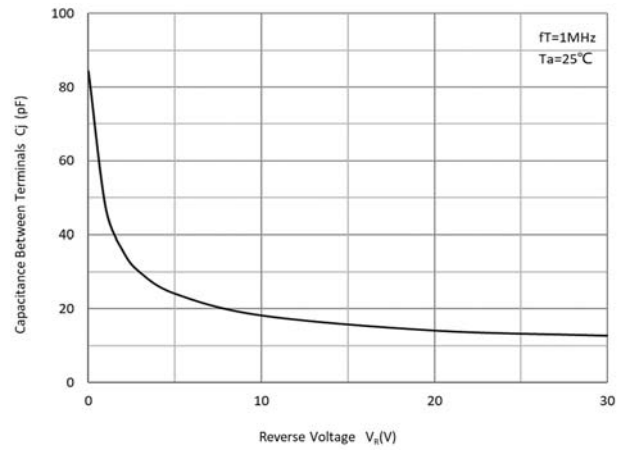

Fig 3: Typical Forward Characteristics

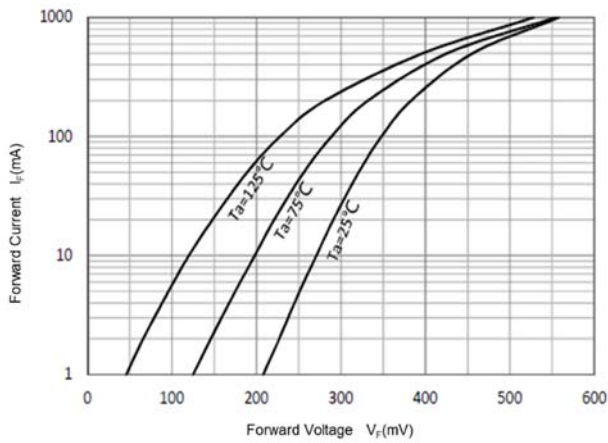
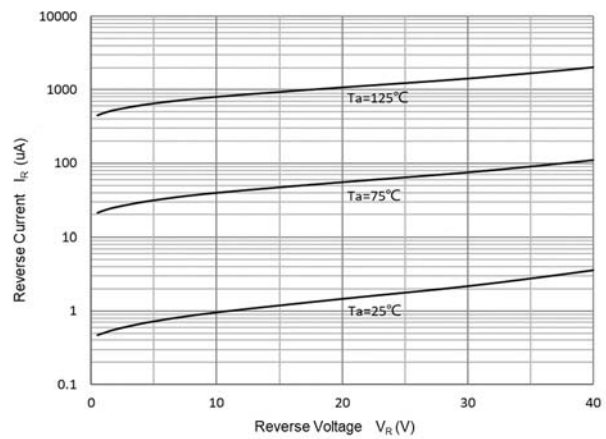

Fig 4: Typical Reverse Characteristics





B0540W

RoHS
COMPLIANT

■ Ordering Information

Preferred P/N	Packing code	Unit weight(g)	Minimum package(pcs)	Inner box quantity(pcs)	Outer carton quantity(pcs)	Delivery mode
B0540W	F2	Approximate 0.011	3000	30000	120000	7" reel
B0540W	F3	Approximate 0.011	10000	/	210000	13" reel

■ Outline Dimensions

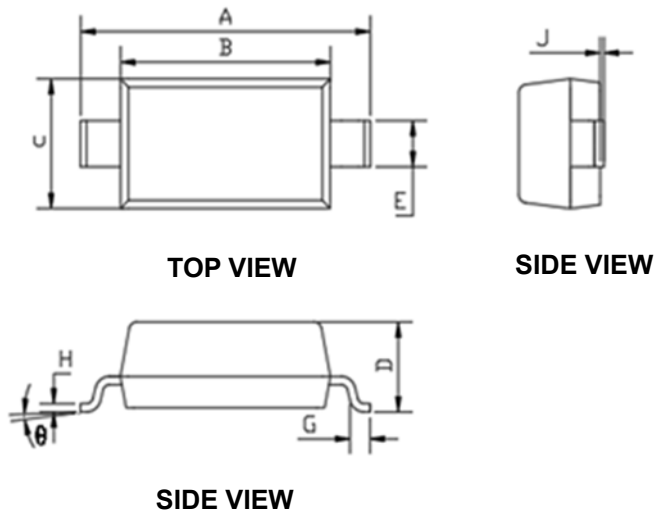

DIMENSIONS				
DIM	INCHES		MM	
	MIN	MAX	MIN	MAX
A	0.140	0.152	3.550	3.850
B	0.100	0.112	2.550	2.850
C	0.055	0.071	1.400	1.800
D	0.037	0.053	0.950	1.350
E	0.020	0.028	0.510	0.710
G	0.006	0.018	0.150	0.450
H	0.003	0.010	0.080	0.250
J	0.000	0.006	0.000	0.150
θ	0	8°	0	8°

■ Suggested Pad Layout

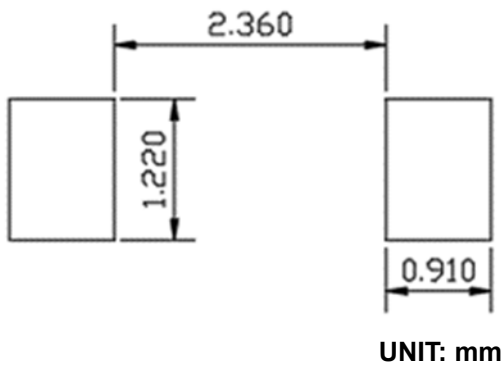



Disclaimer

The information presented in this document is for reference only. Yangzhou Yangjie Electronic Technology Co., Ltd. reserves the right to make changes without notice for the specification of the products displayed herein to improve reliability, function, or design or otherwise.

The product listed herein is designed to be used with ordinary electronic equipment or devices, and not designed to be used with equipment or devices which require high level of reliability and the malfunction of which would directly endanger human life (such as medical instruments, transportation equipment, aerospace machinery, nuclear-reactor controllers, fuel controllers and other safety devices), Yangjie or anyone on its behalf, assumes no responsibility or liability for any damages resulting from such improper use of sale.

This publication supersedes & replaces all information previously supplied. For additional information, please visit our website [http:// www.21yangjie.com](http://www.21yangjie.com) , or consult your nearest Yangjie's sales office for further assistance.